



# Assembly instruction Conductor rails

End joint

-

Central connection



## Conductor rail with end joint

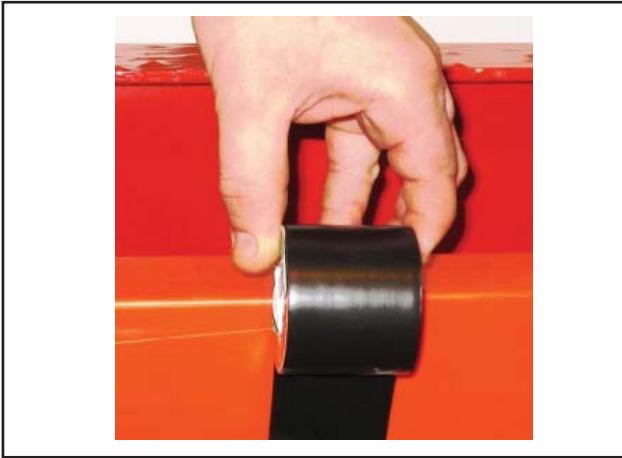

**Fig. 1**



**Fig. 2**

### **T50 insulation tape**

Joints between two rail lengths should be covered with T50 insulation tape.

**See Fig. 1**

### **Joint clamp**

The joint clamp is fitted with barbs that fix the rail into position when the two parts are pushed together. This enables you to join the conductor rail together quickly and safely.

Once the rail is in place we recommend that the current collector is laid through the rail to ensure that the joints are working properly, this must be done after the copper conductors are marked.

Check that the track along the rail is clear and not distorted by the joint clamps (the track should be 10 mm). If necessary, you can adjust the track by bending the joint clamp until you achieve the required clearance.

**See Fig. 2**



Fig. 3

### Angle iron

The rail is fixed to an angle iron, which is then fitted with clamps to the top of the I profile or directly onto the ceiling. **See Fig. 3**

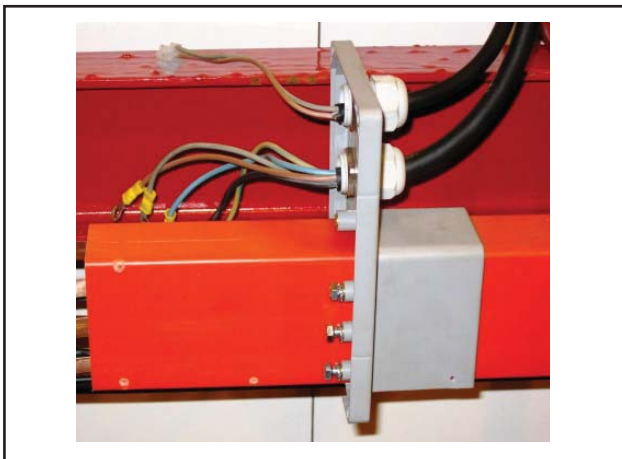

Fig. 4

### End joints

Move the sleeve to the end switch box at the end of the rail.

**See Fig. 4**

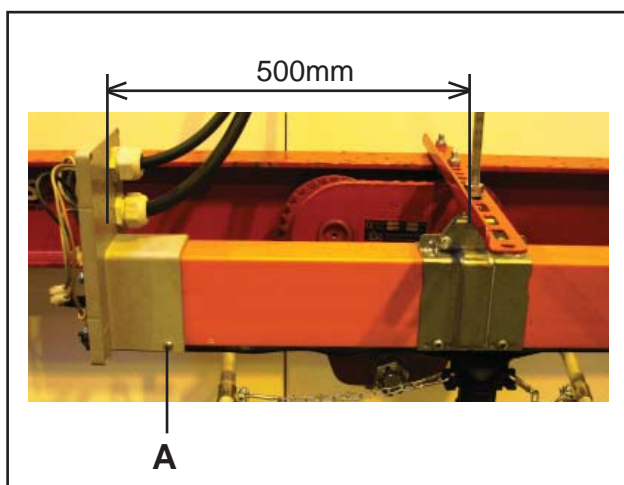

Fig. 5

### Sleeve

Once the sleeve has been positioned at the end of the conductor rail it must be fixed using the appropriate screws (**A**).

The distance between end terminal box and fixed suspension should be 500 mm.

**See Fig. 5**

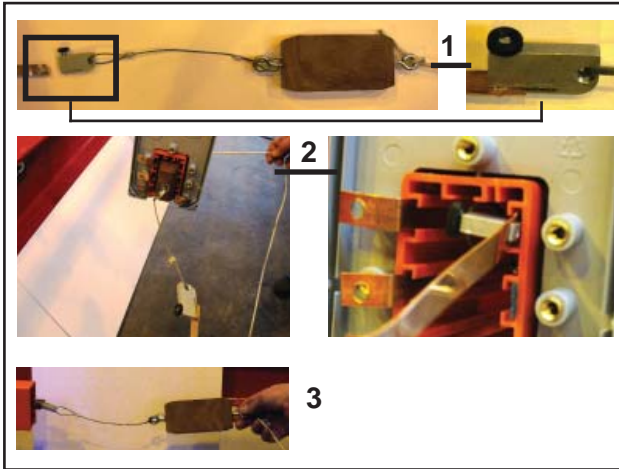

Fig. 6

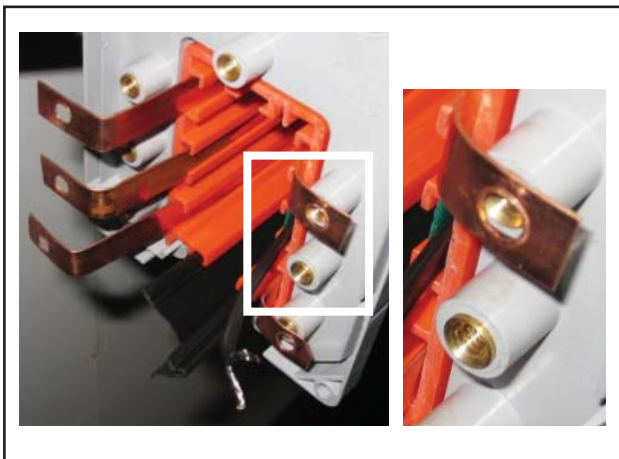

Fig. 7

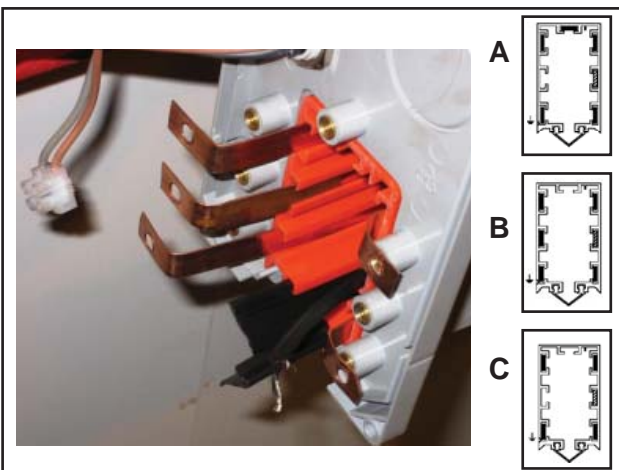

Fig. 8

## Trolley

Lay the copper wire from the end of the track using a trolley.

**The trolley is not supplied.**

### Picture 1

Attach the trolley to a  $\varnothing 6$  hole in the copper wires.

### Pictures 2–3

Feed the trolley into the conductor rail and pull it through the rail until it reaches the other side.

**See Fig. 6**

## Copper wires

The trolley pulls the copper wires through the conductor rail until the bent end pushes against the rail.

**See Fig. 7**

## Copper wire connections

The copper strips are then connected to the various currents and their associated wires.

**See symbols and abbreviations for copper wires on page 29, Fig. 17a - 17b - 17c**

- A 400V 3-pole + N
- B 400V 3-pole + N (Straight rail)
- C 230V 3-pole

**See Fig. 8**

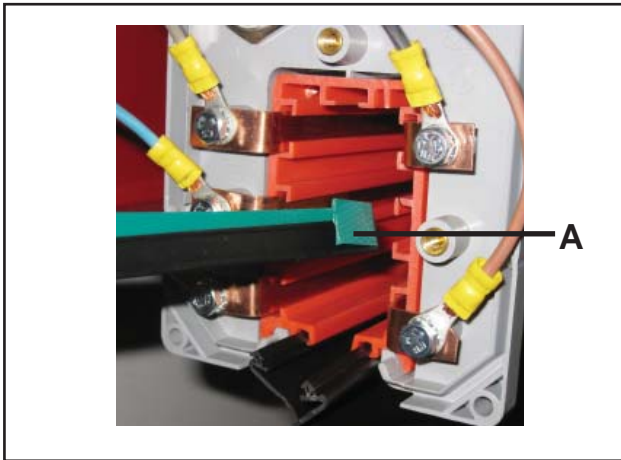

Fig. 9

### Heating cable

Heating cables with insulation strips are fed into the conductor rail.

**See Fig. 9**

The green insulation strip (**A**) must face inwards on the conductor rail.

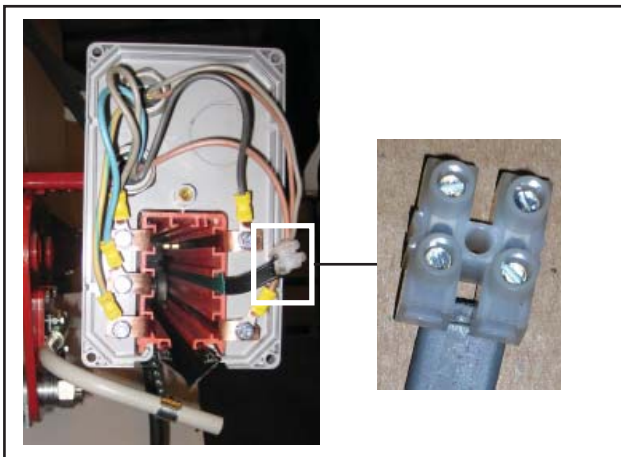

Fig. 10

### Heating cable connections

The heating cable is connected to a terminal block with a 230V – 10/16A separate circuit.

**See Fig. 10**

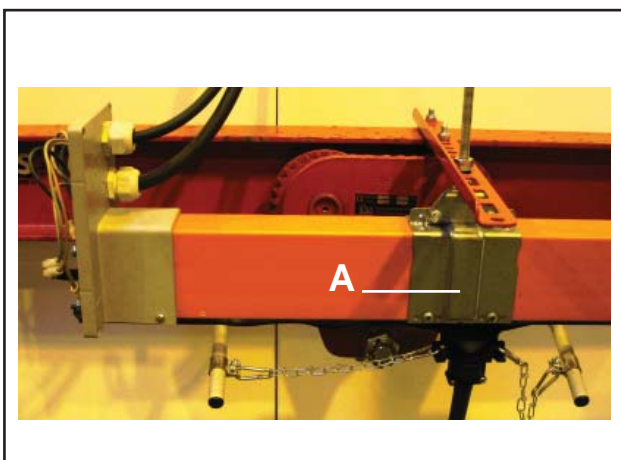

Fig. 11

### Suspension clamp

Fit the fixed suspension clamp (**A**) near the end joint. **See Fig. 11**



Fig. 12

### Fitting the rubber seal

Insert the protective membrane rail into the horizontal track underneath the conductor rail either manually or, in the case of long pieces of membrane, by using specialist equipment (consult TKS).

The rubber seal should be fitted to both sides to achieve a better enclosure rating (IP44)

**See Fig. 12**

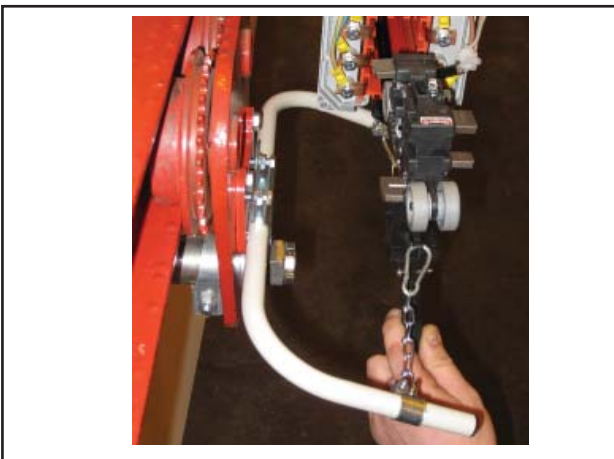

Fig. 13

### Current collector

The current collectors are inserted into the casing on the conductor rail. The current collector is controlled by a link bracket attached to the traversing carriage or trolley.

Individual adaptation may be necessary depending on where it is located.

#### NB!

Ensure the cable does not pull the current collector trolley askew.

**See Fig. 13**



Fig. 14

### Chain

On each bracket a chain should be fitted that will pull the collector horizontally. It is important that the chain pulls parallel with the opening in the conductor rail. See next picture.

**See Fig. 14**

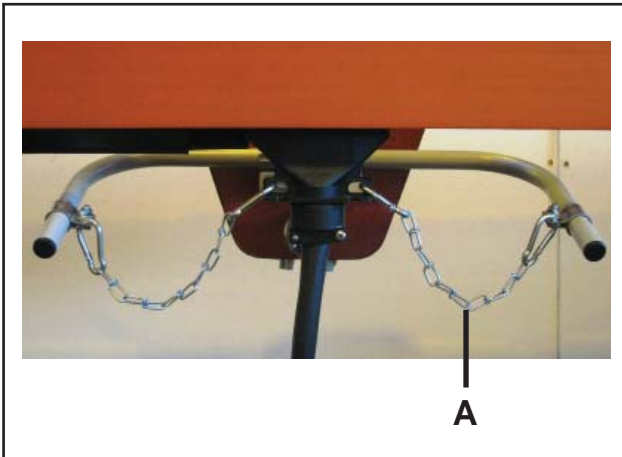

Fig. 15

### Even pull on the chain

It is important that the chain (A) pulls evenly (not skewed) and slightly downwards (1–3 cm). This is particularly important when operating in curves.

See Fig. 15

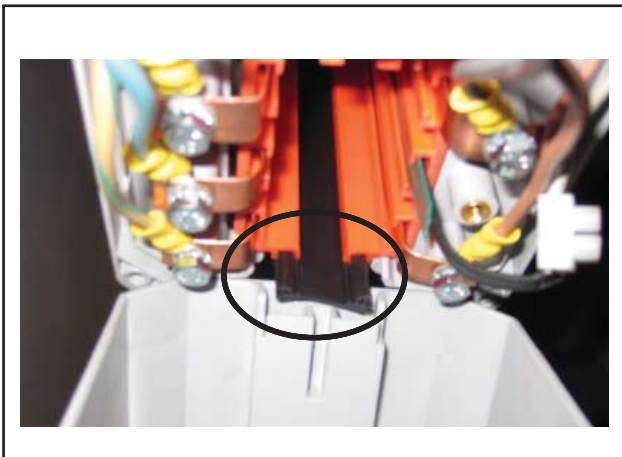

Fig. 16

### Rubber seal

Ensure that the inserting part of the rubber seal is laid inside the track on the end casing.

See Fig. 16

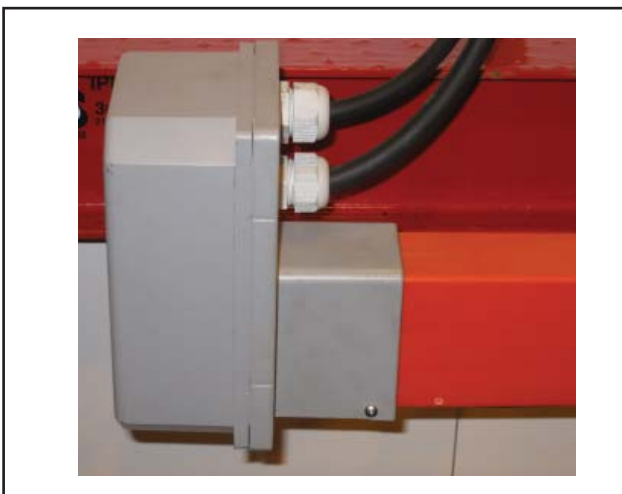

Fig. 17

### End casing

Straighten the construction and fix the end casing using the appropriate screws.

See Fig. 17

## Conductor rail with end joint

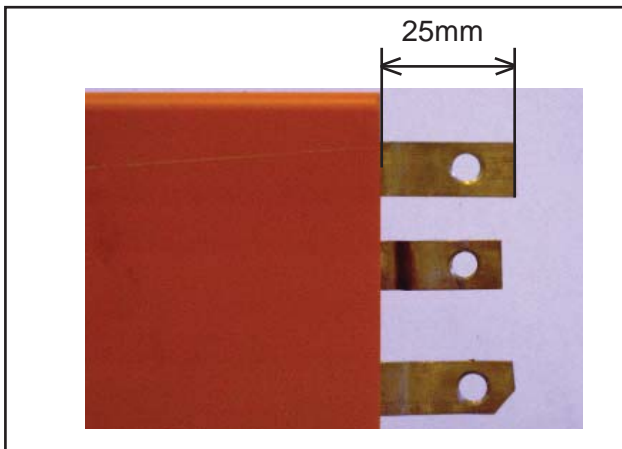
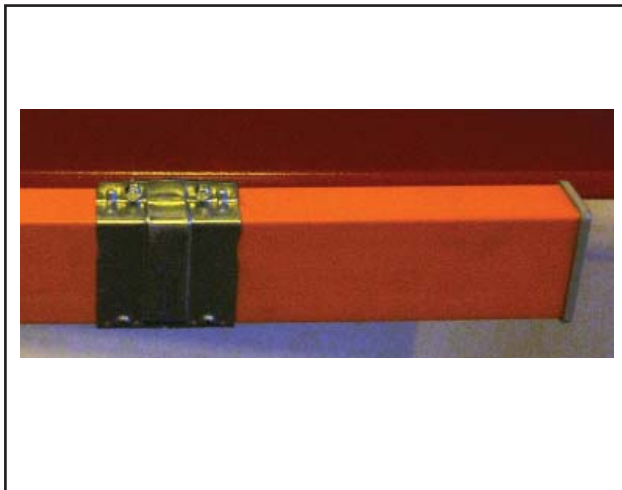

**Fig. 18**

### **Copper conductors**

The ends of the copper conductors should be cut 25 mm outside the rail.

**See Fig. 18**



**Fig. 19**

### **Connector**

Fit the end plug. Fix the joint clamp over the insulation tape and adjust it to obtain the required clearance.

**See Fig. 19**



## Conductor rail with central connection

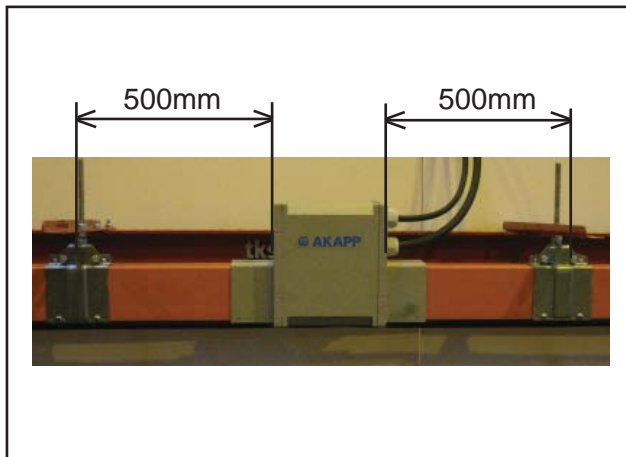

Fig. 20

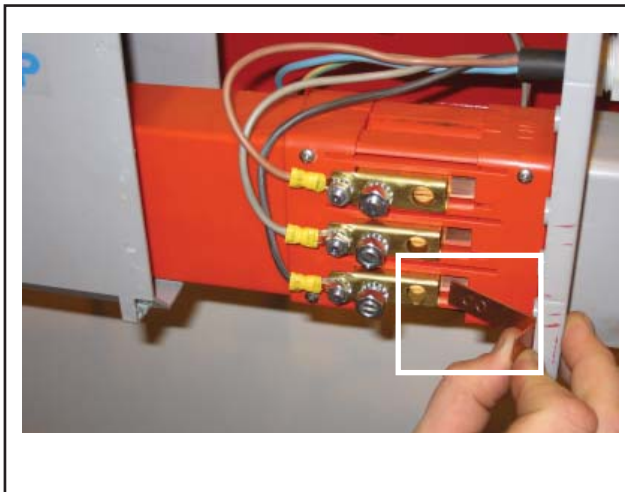

Fig. 21

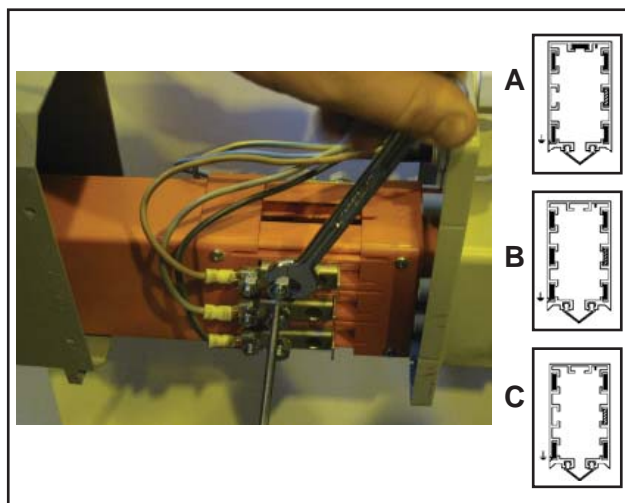

Fig. 22

### Central switch box

Fit the central switch box with the sleeves from the box already inserted in both ends. Fit the central switch box with two fixed suspension clamps on each side.

#### NB!

A central switch box requires fixed suspension on either side of the supply box. A distance of 500 mm on either side is required. .

See Fig. 20

### Clamps

Connect supply cable to clamps after clamps have been inserted into grooves.

See Fig. 21

### Laying the copper conductors

The copper conductors are laid in the same way as for rails with end connections but can be done from either end.

See Fig. 22

#### NB!

Remember to feed the copper conductors through the connection clamps when laying the conductors.



Fig. 23

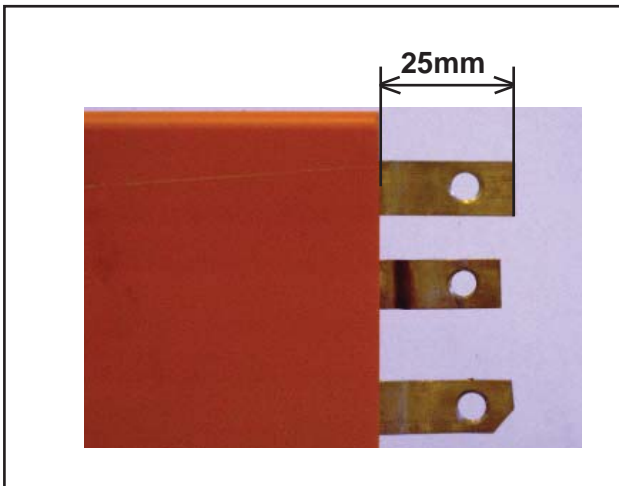

Fig. 24

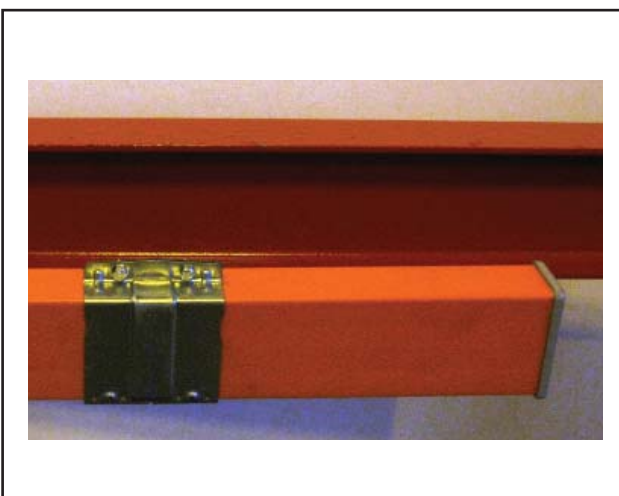

Fig. 25

### Power supply

The supply cable should be connected using the appropriate screws. For power supply, connect the heating wires to a terminal block. See Fig. 23

### Copper conductors

Just as for rails with end connections, the copper conductors that are fed through the conductor rail should be cut 25 mm outside the rail because of the expansion of the rail (during large temperature fluctuations).

See Fig. 24

### Conductor rail end casing

After cutting the copper conductors to 25 mm, fix the end casing using the appropriate connector. This is the same procedure as for conductor rails with end connections.

See Fig. 25

**Fig. 26****Rubber seal**

Insert the rubber seal by hand or use specialist equipment in the case of long pieces.

**See Fig. 26**

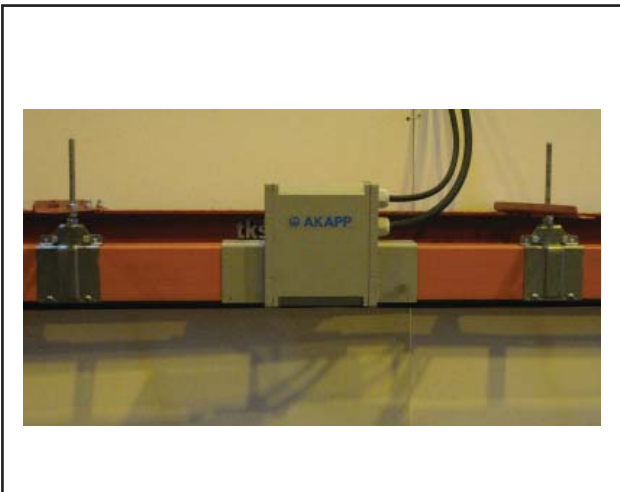
**Fig. 27****Central switch box**

The central connection should be fixed to the conductor rail using the appropriate screws.

**See Fig. 27**

**Maintenance and inspection**

It is recommended that the current collector is inspected after 1 month of operation, then every 1000 km or once a year thereafter.

**NB!**

Sweep the protective membrane along the conductor rail with a brush/sponge to prevent wear and verdigris on the copper conductors due to dust and moisture.

**TKS is a family owned company  
with a strong brand name.  
We are providing our customers with a  
unique and complete range of high  
quality products.**

**[www.tks-as.no](http://www.tks-as.no)**



**T. Kverneland & Sønner AS,  
Kvernelandsvegen 100  
N-4355 Kvernaland  
Norway**

**e-post : [post@tks-as.no](mailto:post@tks-as.no)  
Phone +47 51 77 05 00  
Fax +47 51 48 72 28**